

2022

# Supplies & Accessories



Cutting plotter



Instrument products



Label cutter



Others

## Graphtec Supplies & Accessories

---

### Cutting plotter

- |  |                                      |
|--|--------------------------------------|
| 1. Cutting blade                           | 11. Pouncing tool                    |
| 2. Cutting blade holder                    | 12. Creasing / Scoring tool          |
| 3. Pen adapter                             | 13. Loupe                            |
| 4. Life time of CB09 series                | 14. Water-based fiber-tip pen        |
| 5. Blade type and typical application      | 15. Water-based fiber-tip pen holder |
| 6. Blade and the corresponding holder List | 16. Oil-based ballpoint pen          |
| 7. Cutting mat                             | 17. Oil-based ballpoint pen holder   |
| 8. Protect sheet                           | 18. Push roller                      |
| 9. Adsorption mat                          | 19. Rubbing Protection Tape          |
| 10. Cross cutter blade                     |                                      |

---

### Instrument products

- |                                 |                                   |
|---------------------------------|-----------------------------------|
| 1. Cable                        | 4. Recording Paper (Z-fold paper) |
| 2. Shunt resistor               | 5. Recording pen                  |
| 3. Recording paper (Roll paper) |                                   |

---

### Label cutter DLC1000

- |                        |
|------------------------|
| 1. Paper core          |
| 2. Cutter blade        |
| 3. Cutter blade holder |
| 4. Cutting mat         |
| 5. Loupe               |

---

### Others

- |                |
|----------------|
| 1. Scanners    |
| 2. Auto feeder |

---













\*:Model numbers are switched to the new ones as soon as the stocks with the old model numbers run out.

\*:Availability of items could vary depending on the regions.

**Supported product** CE6000Plus / CE6000 / CE7000 / FC8600 / FC9000 / CE LITE-50 / FC4500 / FC2250 / FCX2000 / FCX4000





**Published item** 1. Cutting blade 2. Cutting blade holder 3. Pen adapter 4. Blade type and typical application 5. Blade and the corresponding holder List  
6. Cutting mat 7. Protect sheet 8. Adsorption mat 9. Cross cutter blade 10. Pouncing tool 11. Creasing / Scoring tool 12. Loupe  
13. Water-based fiber-tip pen 14. Water-based fiber-tip pen holder 15. Oil-based ballpoint pen 16. Oil-based ballpoint pen holder

### 1. Cutting blade

Item	Model No.	Description	Package	Supported product										
				Grit rolling type				Flatbed type						
				CE LITE-50	CE6000PLUS	CE6000	CE7000	FC8600	FC9000	FC4500	FCX4000	FC2250	FCX2000	
	CB09-L	Blade, 0.9 mm diameter. Angle 45° Life : less 2km (Paper), less 3km (Vinyl)	5blades/pack		●	●	●	●	●	●	●	●	●	●
	CB09-E	Blade, 0.9 mm diameter. Angle 45° Life : 2-3km (Paper), 5km (Vinyl)	5blades/pack		●	●	●	●	●	●	●	●	●	●
	CB09UB-5	Blade, 0.9 mm diameter. Angle 45° Life : 4-5km (Paper), 10-12km (Vinyl)	5blades/pack		●	●	●	●	●	●	●	●	●	●
	CB09-P	Blade, 0.9 mm diameter. Angle 45° Life : 7-8km (Paper), 28-30km (Vinyl)	5blades/pack		●	●	●	●	●	●	●	●	●	●
	CB09UB-K60-5	Blade, 0.9 mm diameter. Angle 60° For tint film, car protection film, 0.03 mm to 0.25 mm thick	5blades/pack		●	●	●	●						
	CB15U-5	Blade, 1.5 mm diameter. Angle 45° For heavy paper/board, 0.25 mm to 0.5 mm thick	5blades/pack		●	●	●	●	●	●	●	●	●	●
	CB15U-K30-5	Blade, 1.5 mm diameter. Angle 30° For heat transfer media (Brick, Flock), Magnet sheet, Rubber sheet for Sandblast, 0.25 mm to 1.1 mm thick	5blades/pack		●	●	●	●	●	●	●	●	●	●
	CB15UA-5	Blade, 1.5 mm diameter. Angle 45° For high-intensity reflective film (3M Engineer Grade), up to 0.5 mm thick	5blades/pack					●	●	●	●	●	●	●
	CB15UA-K30-5	Blade, 1.5 mm diameter. Angle 30° For high-intensity reflective film (3M Diamond Grade), up to 1.0 mm thick	5blades/pack					●	●	●	●	●	●	●
	CB30UC-1	Blade, 3.0 mm diameter. Angle 45° For cardboard and corrugated board (E,F,G flute), up to 2.0 mm thick	1blade/pack										●	●
	PM-CB-001	Blade, 3.0 mm diameter. Angle 30° For plastic corrugated board, 1.0 mm to 3.0 mm thick	2blades/pack											●
	PM-BS-001	Blade for normal media (film, paper, others)	1pc/pack	●										
	PM-BS-002	Blade for thick media (soft rubber, polyurethane sheet, up to 1 mm)	1pc/pack	●										

● : Available

## 2. Cutting blade holder

Item	Model No.	Description	Package	Supported product									
				Grit rolling type				Flatbed type					
				CE LITE-50	CE6000 CE6000PLUS	CE7000	FC8600	FC9000	FC4500	FCX4000	FC2250	FCX2000	
	PHP33-CB09N-HS	Blade holder for CB09U series blade with plastic tip	1pc/pack		●	●	●	●	●	●	●	●	●
	PHP33-CB15N-HS	Blade holder for CB15U series blade with plastic tip	1pc/pack		●	●	●	●	●	●	●	●	●
	PM-CH-001	Blade holder for CB30UC/PM-CB-001 cutting blade	1pc/pack									●	●
	PHP35-CB09-HS	Blade holder for CB09U series blade with metal tip	1pc/pack				●	●	●	●	●	●	●
	PHP35-CB15-HS	Blade holder for CB15U series blade with metal tip	1pc/pack				●	●	●	●	●	●	●











● : Available

## 3. Pen adapter

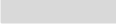
Item	Model No.	Description	Package	Supported product									
				Grit rolling type				Flatbed type					
				CE LITE-50	CE6000 CE6000PLUS	CE7000	FC8600	FC9000	FC4500	FCX4000	FC2250	FCX2000	
	PM-BH-001	Pen adapter for commercially available fiber-tip or ballpoint pen	1set/pack	●									

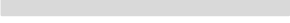
● : Available

#### 4. Life time of CB09 series









Item	Model No.		
	CB09-L	Paper	 Less 2km
		Vinyl	 Less 3km
	CB09-E	Paper	 2-3km
		Vinyl	 5km
	CB09UB-5	Paper	 4-5km
		Vinyl	 10-12km
	CB09-P	Paper	 7-8km
		Vinyl	 28-30km

#### 5. Blade type and typical application

We offer several high-quality blade for each material so that it can be used in a variety of applications.













⊙: Best solution

●: Available

Item	Model No.	Diameter	Angle	Suitable media type	Supported product					
					Grit rolling type			Flatbed type		
					CE7000plus	CE7000	FC9000 FC8600	CE LITE-50	FCX2000	FCX4000
	CB09 series	φ0.9mm	45°	Self-adhesive marking film (vinyl, fluorescent, reflective), Paper, Heat transfer media [Thickness] up to 0.25mm	⊙	⊙			●	●
	CB09UB-K60-5		60°	Tint film, Car protection film [Thickness] up to 0.25mm	●	⊙				
	CB15U-5	φ1.5mm	45°	Heavy paper/board [Thickness] up to 0.5mm	●	●			⊙	⊙
	CB15U-K30-5		30°	Heat transfer media (Brick, Flock), Magnet sheet, Rubber sheet for Sandblast [Thickness] up to 1.1mm	⊙	●			●	●
	CB15UA-5		45°	High intensity reflective film (3M Engineer Grade) [Thickness] up to 0.5mm			⊙		●	●
	CB15UA-K30-5		30°	High intensity reflective film (3M Diamond Grade) [Thickness] up to 1.0mm			⊙		●	●
	CB30UC-1	φ3.0mm	45°	Cardboard, Corrugated board (E,F,G flute) [Thickness] up to 2.0mm * Cutting accuracy is not guaranteed. Be sure to try it before using it.					⊙	
	PM-CB-001		30°	Plastic corrugated board [Thickness] 1.0 ~ 3.0mm * Cutting accuracy is not guaranteed. Be sure to try it before using it.					⊙	





## 6. Blade and the corresponding holder List

● : Available

			Supported holder				
			PHP33- CB09N-HS Spring built-in type	PHP35- CB09-HS Spring built-in type	PHP33- CB15N-HS Spring built-in type	PHP35- CB15-HS Spring built-in type	PM-CH-001
Blade							
Diameter	Item	Model No.					
φ0.9mm		CB09 series	●	●			
		CB09UB-K60-5	●	●			
φ1.5mm		CB15U-5			●	●	
		CB15U-K30-5			●	●	
		CB15UA-5			●	●	
		CB15UA-K30-5			●	●	
φ3.0mm (*1)		CB30UC-1					●
		PM-CB-001					●

(\*1) Cutting accuracy is not guaranteed. Be sure to try it before using it.

## 7. Cutting mat

Item	Model No.	Description	Package	Supported product															
				Grit rolling type					Flatbed type										
				CE LITE-50	CE6000 CE6000PLUS	CE7000	FC8600	FC9000	FC4500	FCX4000	FC2250	FCX2000							
	<b>PM-CR-001</b>	Cutting mat for CE LITE-50	1pc/pack	●															
	<b>CE6-CM40-2</b>	Cutting mat for CE6000-40/PLUS	2pcs/pack		●														
	<b>CE6-CM60-2</b>	Cutting mat for CE6000-60/PLUS	2pcs/pack		●														
	<b>CE6-CM120-2</b>	Cutting mat for CE6000-120/PLUS	2pcs/pack		●														
	<b>U621390470</b>	Cutting mat for FC8600-60	1pc/pack					●											
	<b>U621261470</b>	Cutting mat for FC8600-75	1pc/pack					●											
	<b>U621271470</b>	Cutting mat for FC8600-100	1pc/pack					●											
	<b>U621281470</b>	Cutting mat for FC8600-130	1pc/pack					●											
	<b>U621291470</b>	Cutting mat for FC8600-160	1pc/pack					●											
	<b>U621399900</b>	Cutting mat for FC8600	1roll/pack					●											
		<b>PM-CR-005</b>	Cutting mat for FC9000-75	2pcs/pack						●									
<b>PM-CR-006</b>		Cutting mat for FC9000-100	2pcs/pack						●										
<b>PM-CR-007</b>		Cutting mat for FC9000-140	2pcs/pack						●										
<b>PM-CR-008</b>		Cutting mat for FC9000-160	2pcs/pack						●										
<b>PM-CR-009</b>		Cutting mat for CE7000-40	2pcs/pack				●												
<b>PM-CR-010</b>		Cutting mat for CE7000-60	2pcs/pack				●												
<b>PM-CR-011</b>		Cutting mat for CE7000-130/130AP	2pcs/pack				●												
<b>PM-CR-012</b>		Cutting mat for CE7000-160	2pcs/pack				●												





● : Available

## 8. Protect sheet

Item	Model No.	Description	Package	Supported product															
				Grit rolling type					Flatbed type										
				CE LITE-50	CE6000 CE6000PLUS	CE7000	FC8600	FC9000	FC4500	FCX4000	FC2250	FCX2000							
	<b>PM-CR-002A</b>	Writing panel protect sheet (for FCX4000-50ES)	1sheet/pack									●							
	<b>PM-CR-003A</b>	Writing panel protect sheet (for FCX4000-60ES)	1sheet/pack									●							
	<b>PM-CR-004A</b>	Writing panel protect sheet (for FCX2000-120ES)	1sheet/pack																●



● : Available

## 9. Adsorption mat

Item	Model No.	Description	Package	Supported product											
				Grit rolling type				Flatbed type							
				CE LITE-50	CE6000PLUS	CE6000	CE7000	FC8600	FC9000	FC4500	FCX4000	FC2250	FCX2000		
	<b>CM-0003-R1A</b>	Double-side coated roll, size 545 mm x 20 m, for plastic materials	1roll/pack									●	●	●	●
	<b>PM-CM-001</b>	Cling mat for film based type material, size 660 mm x 488 mm	2sheets/pack										●	●	●
	<b>PM-CM-002</b>	Cling mat for creasing, size 660 mm x 488 mm	2sheets/pack										●	●	●
	<b>PM-CM-003A</b>	Carrier sheet for media without backing paper Supported media size: 330mm x 483mm * Please consider to use with optional carrier sheet table "OPH-A45" for CE7000-40/60.	1sheet/pack	●	●	●									

● : Available

## 10. Cross cutter blade

Item	Model No.	Description	Package	Supported product												
				Grit rolling type				Flatbed type								
				CE LITE-50	CE6000PLUS	CE6000	CE7000	FC8600	FC9000	FC4500	FCX4000	FC2250	FCX2000			
	<b>CT01H</b>	Cross cutter blade, Standard type	1pc/pack													
	<b>CT02U</b>	Cross cutter blade, High durability type	1pc/pack													
	<b>PM-CC-002</b>	Cross cutter blade, Super steel type	1pc/pack							●						

● : Available











## 11. Pouncing tool

Item	Model No.	Description	Package	Supported product									
				Grit rolling type				Flatbed type					
				CE LITE-50	CE6000 CE6000PLUS	CE7000	FC8600	FC9000	FC4500	FCX4000	FC2250	FCX2000	
	PPA33-TP12	Steel pin 1.2 mm diameter	1pc/pack				●	●					

● : Available

## 12. Creasing / Scoring tool

Item	Model No.	Description	Package	Supported product									
				Grit rolling type				Flatbed type					
				CE LITE-50	CE6000 CE6000PLUS	CE7000	FC8600	FC9000	FC4500	FCX4000	FC2250	FCX2000	
	CP-001	 Stick type creasing tool, for heavy paper	1pc/pack							●	●	●	●
	CP-002	 Roller type creasing tool (R0.2 mm), for heavy paper	1pc/pack									●	●
	CP-003	 Roller type creasing tool (R0.6 mm), for cardboard	1pc/pack									●	●
	PM-CT-002	 Ball on tip of stick creasing tool, for curve line on heavy paper	1pc/pack								●	●	●



● : Available

## 13. Loupe

Item	Model No.	Description	Package	Supported product									
				Grit rolling type				Flatbed type					
				CE LITE-50	CE6000 CE6000PLUS	CE7000	FC8600	FC9000	FC4500	FCX4000	FC2250	FCX2000	
	PM-CT-001	Loupe for checking blade length, for PHP33 and PHP35 series	1pc/pack		●	●	●	●	●	●	●	●	●

● : Available

## 14. Water-based fiber-tip pen

					Supported product							
					Grit rolling type				Flatbed type			
Item	Model No.	Description	Package	CE LITE-50	CE6000 CE6000PLUS	CE7000	FC8600	FC9000	FC4500	FCX4000	FC2250	FCX2000
	KF700-BK	Pen, Black	10pens/pack		●	●	●	●		●	●	●
	KF700-RD	Pen, Red	10pens/pack		●	●	●	●		●	●	●

● : Available

## 15. Water-based fiber-tip pen holder

					Supported product							
					Grit rolling type				Flatbed type			
Item	Model No.	Description	Package	CE LITE-50	CE6000 CE6000PLUS	CE7000	FC8600	FC9000	FC4500	FCX4000	FC2250	FCX2000
	PHP31-FIBER	Pen holder for KF700 series pen	1set/pack		●	●	●	●		●	●	●

● : Available

## 16. Oil-based ballpoint pen

					Supported product							
					Grit rolling type				Flatbed type			
Item	Model No.	Description	Package	CE LITE-50	CE6000 CE6000PLUS	CE7000	FC8600	FC9000	FC4500	FCX4000	FC2250	FCX2000
	KB700-BK	Pen, Black	10pens/pack		●	●	●	●	●	●	●	●



● : Available

## 17. Oil-based ballpoint pen holder

					Supported product							
					Grit rolling type				Flatbed type			
Item	Model No.	Description	Package	CE LITE-50	CE6000 CE6000PLUS	CE7000	FC8600	FC9000	FC4500	FCX4000	FC2250	FCX2000
	PHP34-BALL	Pen holder for KB700-BK	1set/pack		●	●	●	●	●	●	●	●

● : Available

## 18. Push roller

					Supported product							
					Grit rolling type				Flatbed type			
Item	Model No.	Description	Package	CE LITE-50	CE6000 CE6000PLUS	CE7000	FC8600	FC9000	FC4500	FCX4000	FC2250	FCX2000
	U792900970	Push Rollers for CE6/CE7/FC86/FC9	10pcs/pack		●	●	●	●				
	U792900900	Push Roller with snap pin for CE6/CE7/FC86/FC9	1set/pack		●	●	●	●				

● : Available

## 19. Rubbing Protection Tape

					Supported product							
					Grit rolling type				Flatbed type			
Item	Model No.	Description	Package	CE LITE-50	CE6000 CE6000PLUS	CE7000	FC8600	FC9000	FC4500	FCX4000	FC2250	FCX2000
	U792999800	Rubbing Protection Tape for front guide, 19mm x 10M	1roll/pack				●	●				







● : Available

## Instrument products

**Supported product** GL7000 Plus / GL900 series / GL980 / GL2000 / GL240 series / GL840 / GL100 series / MT100 / WR3320A series / DP-581H

**Published item** 1. Cable 2. Shunt resistor 3. Recording paper (Roll paper) 4. Recording Paper (Z-fold paper) 5. Recording pen

### 1. Cable

Item	Model No.	Description	Package	Supported product														
				GL7000 Plus	GL900 series	GL980	GL2000	GL240 series	GL840 series	GLT400	GL100 series	MT100	WR3320A-2H	WR3320A-4H	WR3320A-1DH	WR3320A-2DH	DP-581H	
	RIC-142	Input cable, 1.5m length, 1000 VDC Voltage, CAT II (600V · CAT III)	1pc/pack	●*	●	●	●											
	RIC-143	Input cable, 1.6m length, 600 VDC Voltage, CAT II (300V · CAT III), Banana-BNC	1pc/pack	●*	●	●	●											
	RIC-144A	Clip, 11mm Aperture, 300VDC Voltage, CAT II, 15A Power consumption, Cable (Optional)	One Set (Red/Black)															
	RIC-145	Clip, 20mm Aperture, 1000 VDC Voltage, CAT II, 32A Power consumption, Cable (Optional)	One Set (Red/Black)															
	RIC-146	Clip, 5mm Aperture, 1000 VDC Voltage, CAT III, 1A Power consumption, Cable (Optional)	One Set (Red/Black)															
	RIC-147	Input cable, 1.6m length, 1000 VDC Voltage, CAT II	One Set	●*	●	●	●											
	SMA-102	Input terminal adapter	1pc/pack	●*	●	●	●											

\*This option is not available for use depends on the type of amplifier, terminal block, or terminal block cover.

●: Available

### 2. Shunt resistor

Item	Model No.	Description	Package	Supported product														
				GL7000 Plus	GL900 series	GL980	GL2000	GL240 series	GL840 series	GLT400	GL100 series	MT100	WR3320A-2H	WR3320A-4H	WR3320A-1DH	WR3320A-2DH	DP-581H	
	B-551	Shunt resistor, 250 ohms 0.1% (it converts the signal to the "1-5V" from the "4-20mA"), 1W Power consumption, 15.8V Max. voltage	1pc/pack	●*	●	●	●	●	●	●	●	●	●	●	●	●	●	●

\*This option is not available for use depends on the type of amplifier, terminal block, or terminal block cover.

●: Available

### 3. Recording paper (Roll paper)

Item	Model No.	Description	Package	Supported product																		
				GL7000 Plus	GL900 series	GL980	GL2000	GL240 series	GL840 series	GL7400	GL100 series	MT100	WR3320A-2H	WR3320A-4H	WR3320A-1DH	WR3320A-2DH	DP-581H					
	PR410-2B-R5A	Thermal paper, Black, 40 mm x 2 ch, 100 m length	5rolls/pack																			
	PR412-4B-R5A	Thermal paper, Black, 40 mm x 4 ch, 100 m length	5rolls/pack																			
	PR420-1B-R5A	Thermal paper, Black, 80 mm x 2 ch, 100 m length	5rolls/pack																			
	PR-210X30	Thermal paper, Black, 200 mm x 1 ch 30 m length	6rolls/pack																			
	PR230-R5A	Chart paper, Roll, Black, 110 mm x 40 m, WR300	5rolls/pack																			
	PR231A-R10A	Chart paper, Roll, Black, 210 mm x 40 m, WR300 series 8&16-ch	10rolls/pack																			
	PR413-6B-R5A	Chart paper, Roll, 40 mm x 6 ch, 100 m, WR3320-6	5rolls/pack																			

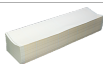

● : Available

### 4. Recording Paper (Z-fold paper)

Item	Model No.	Description	Package	Supported product																		
				GL7000 Plus	GL900 series	GL980	GL2000	GL240 series	GL840 series	GL7400	GL100 series	MT100	WR3320A-2H	WR3320A-4H	WR3320A-1DH	WR3320A-2DH	DP-581H					
	PZ410-2B-R5A	Thermal paper, Black, 40 mm x 2 ch 100 m length	5pcs/pack																			
	PZ412-4B-R5A	Thermal paper, Black, 40 mm x 4 ch 100 m length	5pcs/pack																			
	PZ420-1B-R5A	Thermal paper, Black, 80 mm x 1 ch 100 m length	5pcs/pack																			
	PZ422-2B-R5A	Thermal paper, Black, 80 mm x 2 ch 100 m length	5pcs/pack																			
	PZ230-R5A	Chart paper, Z-fold, 110 mm x 40 m, WR300	5pcs/pack																			
	PZ231A-R5A	Chart paper, Z-fold, 210 mm x 100 m, WR1000, WR8500, WR300	5pcs/pack																			
	PZ233-R5A	Chart paper, Z-fold, Black, 210 mm x 40m, WR300 series 8&16-ch	5pcs/pack																			
	PZ414-8B-R5A	Chart paper, Z-fold, 40 mm x 8 ch, 100 m, WR3320-8	5pcs/pack																			
	PZ424-4B-R5A	Chart paper, Z-fold, 80 mm x 4 ch, 100 m, WR3320-4D	5pcs/pack																			

● : Available

### 5. Recording pen

Item	Model No.	Description	Package	Supported product																		
				GL7000 Plus	GL900 series	GL980	GL2000	GL240 series	GL840 series	GL7400	GL100 series	MT100	WR3320A-2H	WR3320A-4H	WR3320A-1DH	WR3320A-2DH	DP-581H					
 	KT203	Event marker pen	1pen/pack																			
	KT209	Time marker pen	1pen/pack																			



● : Available

## Digital label cutter DLC1000



**Supported product** DLC1000

**Published item** 1. Paper core 2. Cutter blade 3. Cutter blade holder 4. Cutting mat 5. Loupe

### 1. Paper core



				Supported product
Item	Model No.	Description	Package	DLC1000
	<b>DLC-2270R-1CORE-R5</b>	DLC Paper Core 1in x 8.93in (227mm)	5cores/box	●
	<b>PZ-WC-012</b>	DLC Paper Core 3in x 8.50in (216mm)	5cores/box	●

### 2. Cutter blade

				Supported product
Item	Model No.	Description	Package	DLC1000
	<b>CB09-P</b>	Blade, 0.9 mm diameter. Angle 45°	5blades/pack	●
	<b>CB15U-5</b>	Blade, 1.5 mm diameter. Angle 45°	5blades/pack	●

● : Available

### 3. Cutter blade holder

				Supported product
Item	Model No.	Description	Package	DLC1000
	<b>PHP33-CB09N-HS</b>	Blade holder for CB09U series blade with plastic tip	1pc/pack	●
	<b>PHP33-CB15N-HS</b>	Blade holder for CB15U series blade with plastic tip	1pc/pack	●

● : Available

### 4. Cutting mat

				Supported product
Item	Model No.	Description	Package	DLC1000
	<b>CE6-CM40-2</b>	Cutting mat for CE6000-40/PLUS	2pcs/pack	●

● : Available

### 5. Loupe

				Supported product
Item	Model No.	Description	Package	DLC1000
	<b>PM-CT-001</b>	Loupe for checking blade length, for PHP33 and PHP35 series	1pc/pack	●

● : Available

## Others

**Supported product**      **1. Scanners**  
**2. Auto feeder**

### 1. Scanners

**Supported product**      CSX500

Calibration sheet				Supported product
Item	Model No.	Description	Package	<b>CSX500</b>
	<b>IS0932</b>	Calibration sheet for CSX500 series	1pc/pack	●

● : Available

Carrier sheet				Supported product
Item	Model No.	Description	Package	<b>CSX500</b>
	<b>IS0908</b>	Carrier sheet A1 (596 mm x 860 m)	1pc/pack	●
	<b>IS0922</b>	Carrier sheet A0 (896 mm x 1250 m)	1pc/pack	●

● : Available

### 2. Auto feeder

**Supported product**      F-MARK / F-MARK2

Suction cups				Supported product
Item	Model No.	Description	Package	<b>F-MARK / F-MARK2</b>
	<b>U797000027</b>	Suction cups	2pcs/pack	●

● : Available